

WATKINS-JOHNSON CO.  
PALO ALTO, CALIFORNIA

BULK RATE  
U.S. POSTAGE  
PAID  
PERMIT NUMBER  
7577  
SAN FRANCISCO  
CALIFORNIA



Manufacturing  
and Office Locations

## UNITED STATES

### CALIFORNIA

Watkins-Johnson  
3333 Hillview Avenue  
Palo Alto 94304  
Telephone: (415) 493-4141

Watkins-Johnson  
440 Mount Hermon Road  
Scotts Valley 95066  
Telephone: (408) 438-2100

Watkins-Johnson  
11222 La Cienega Blvd.  
Inglewood 90304  
Telephone: (213) 670-4850

### FLORIDA

Watkins-Johnson  
7001 Lake Ellenor Drive  
Orlando 32809  
Telephone: (305) 851-2391

### MARYLAND

Watkins-Johnson  
700 Quince Orchard Road  
Gaithersburg 20760  
Telephone: (301) 948-7550

### MASSACHUSETTS

Watkins-Johnson  
279 Cambridge St., Ste. 113  
Burlington 01803  
Telephone: (617) 272-7235

### NEW YORK

Watkins-Johnson  
808 Shrewsbury Avenue  
New Shrewsbury, N.J. 07724  
Telephone: (201) 842-2422

### OHIO

Watkins-Johnson  
2500 National Rd., Ste. 200  
Fairborn, Ohio 45324  
Telephone: (513) 426-8303

### TEXAS

Watkins-Johnson  
4230 LBJ Freeway  
Dallas 75234  
Telephone: (214) 289-9131

## INTERNATIONAL

### ITALY

Watkins-Johnson Italiana  
S.p.A.  
Piazza G. Marconi, 25  
00144 Roma-EUR  
Telephone: 59 45 54  
Telex: 60117  
Cable: WJROM-ROMA

### UNITED KINGDOM

Watkins-Johnson  
Shirley Avenue  
Windsor, Berkshire SL4 5JU  
Telephone: Windsor 69241  
Telex: 847578  
Cable: WJUKW-WINDSOR

### WEST GERMANY

Watkins-Johnson  
8033 Planegg  
Münchenerstr. 17  
Telephone: (089) 859-9441  
Telex: 529401  
Cable: WJDBM-MUENCHEN

The Watkins-Johnson Tech-notes is a bimonthly periodical circulated to educational institutions, engineers, managers of companies or government agencies, and technicians. Individuals may receive issues of Tech-notes by sending their subscription request on company letterhead, stating position and nature of business to the Editor, Tech-notes, Palo Alto, California. Permission to reprint articles may also be obtained by writing the Editor.

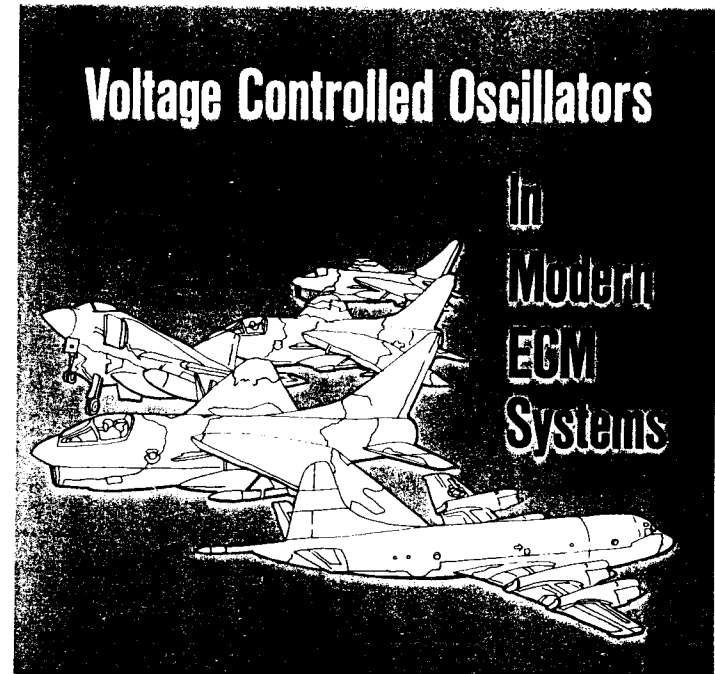

Critical to the success of many electronic countermeasure systems is the performance of the voltage-controlled oscillator (VCO). The oscillator is important to the system due to its ability to simultaneously achieve relatively high power output, large input bandwidth and very fast tuning speed. The varactor-tuned VCO exhibits power output and tuning rates not achievable by any other solid state device. Its power output ranges from a minimum of 50 mW over octave bandwidths from 0.25 to 8 GHz, and 20 mW over 4 GHz segments from 8 to 18 GHz. Its microwave signal can sweep a full frequency band in less than 10 nanoseconds.

Like other solid state devices, the VCO's transition from an experimental laboratory device to a reliable source of microwave energy is primarily due to improvements in semiconductor fabrication technology and circuit design techniques. And like other solid state devices, the oscillator's performance is affected by the same basic constraints of the existing semiconductor technology.

This issue concentrates on two major characteristics of a VCO — modulation sensitivity and post tuning drift. Control of those factors which affect these characteristics has improved VCO performance, and is demonstrated by curves of modulation sensitivity and post tuning drift over several frequency bands for both transistor and bulk-effect diode VCOs. In order to accurately describe the effect of these characteristics on system performance, two applications of the VCO are presented in a modern Electronic Countermeasures (ECM) system.

As part of this article, an index of VCO terminology is supplied on page 10.

### Basic Oscillator Circuit

Wideband varactor-tuned microwave sources most often use a series tuned resonant circuit similar to that shown

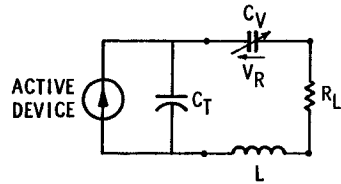

Fig. 1. Simplified equivalent circuit of the varactor-tuned voltage-controlled oscillator.

in Figure 1. In this circuit, the varactor is tuned against the input capacitance of the active device. For a transistor oscillator, the varactor is connected in series with an inductance (L) across the collector-base junction of the active device. The input capacitance ( $C_T$ ) is equal to the collector-base capacitance plus any parasitic capacitances. In a bulk-effect diode oscillator, the varactor is connected in series with the diode through an inductance, L. The input capacitance in this case is equal to the diode capacitance plus any parasitic capacitances.

A varactor diode exhibits a variable capacitance as a function of applied reverse voltage. The equation relating the varactor's junction capacitance to applied voltage is given by:

$$C_V = \frac{C_J(0)}{\sqrt{1 + \frac{V_R}{\phi}}}$$

where  $C_J(0)$  = Junction capacitance at zero volts  
 $V_R$  = Applied reverse voltage  
 $\phi$  = Contact potential

A typical curve of capacitance versus applied voltage for a 5 picofarad varactor is shown in Figure 2.

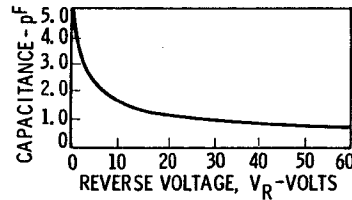

Fig. 2. Capacitance versus Applied Voltage of a 5 pF varactor.

The frequency of oscillation equation for the circuit in Figure 1 is:

$$f_R = \frac{1}{2\pi} \sqrt{\frac{C_T + C_V}{LC_T C_V}}$$

Substitution of the varactor capacitance-voltage equation into this equation indicates that the resonant frequency is proportional to  $(1/V_R)^{-1/4}$ . The frequency, therefore, increases at a decreasing rate as the varactor voltage is increased. Indeed this is the tuning characteristic of a VCO.

The oscillator circuit shown in Figure 1 is a single-ended device since only one active device is used. Other oscillator types which are presently available include the fundamental "push-pull" and doubling "push-push" devices. The active element in any of these may be a transistor or bulk-effect diode. The choice of which active device to use is primarily determined by the desired frequency range. Fundamental "push-pull" transistor oscillators are available up to 6 GHz, while doubling "push-push" transistor oscillators can be made to 12 GHz. Single-ended, bulk-effect diode oscillators

operate above 6 GHz to at least 18 GHz. The GaAs FET has allowed extension of fundamental transistor oscillator coverage into X-Band frequencies. In the 6-12 GHz range, both transistor and bulk-effect diode oscillators are available.

Which type of VCO to use in an application is often determined by two complex requirements, post tuning drift and modulation sensitivity variation. Post tuning drift (PTD) is the shift in the oscillator's frequency output after a step change in tuning voltage and is measured within a specified time. Modulation sensitivity variation is the change in the reciprocal of the slope of the voltage versus frequency tuning curve across a given band expressed in MHz/V. While all varactor-tuned VCOs will exhibit an overall change in modulation sensitivity due to the decrease in rate of change of varactor capacitance with applied voltage, they also exhibit small perturbations or fine grain variations due to parasitics and loading effects. Discussion of modulation sensitivity, as well as post tuning drift, is provided in later sections. First, however, two applications are presented which demonstrate the effect of PTD and modulation sensitivity variation on a modern ECM system's performance.

### An ECM System—Two VCO Applications

Figure 3 is an ECM system that illus-

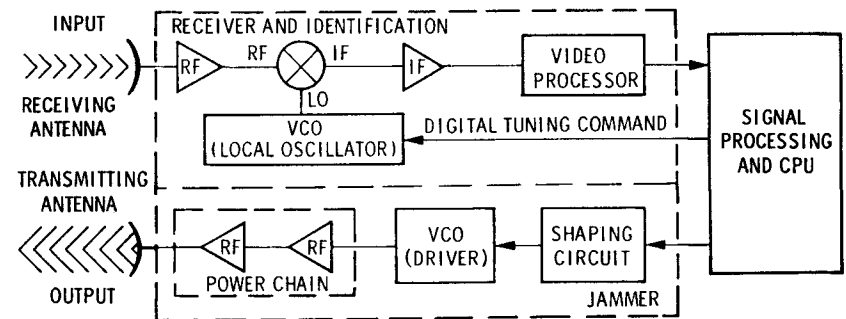

Fig. 3. A Modern ECM System using the VCO as the local oscillator in a passive receiver, and as the driver in an active jammer.

trates two principle applications of the VCO. In this system, the VCO performs as, 1) the local oscillator in a passive receiver and, 2) the driver oscillator at the head of an amplifier chain in a active jammer. As a local oscillator in the receiver application, the VCO's high tuning speed results in high intercept probability in the receiver. Whereas, the VCO in the jammer application must accept modulation rates as high as 100 MHz. The objectives of the passive receiver and active jammer are different; however, the system requirements on the performance characteristics of the VCO are actually very similar for each application.

One of the system's parameters is set-on-accuracy, which is the ability to tune the VCO to the desired frequency over a combination of environmental and system conditions. The second system parameter is set-on-precision, which is the ability to tune the frequency in increments of known magnitude over a wide tuning bandwidth. Equally as important as the first two is the stability of the system after it has received a tuning command that influences both the accuracy and precision of the tuning, and yet be the result of an entirely different performance characteristics. Both set-on-accuracy and set-on-precision parameters are a direct consequence of the VCO's overall and fine grain modulation sensitivity variations.

The system stability after it has been tuned to a new frequency is measured by the post tuning drift performance characteristic. Post tuning drift exists in all microwave sources, and is produced in VCO's by changes that occur in the varactor and the active device, whether the active device be transistor or bulk-effect diode.

In either the active jammer or the passive receiver application, there is an incoming signal at some frequency which must be either masked by jamming, or identified and analyzed by the receiver. Once the jammer is tuned to the incoming frequency, it must not deviate from that frequency within specified limits so that the receiver's IF bandwidth can be filled by the jamming signal. If the jammer does not tune to the correct frequency or drifts from that frequency after being tuned, there is a chance that the threat may not even detect the jamming signal. If the VCO's frequency of operation as a local oscillator is not accurately known because of tuning errors or drift, then the receiver may improperly identify an incoming signal, or fail to detect the signal due to gaps in the coverage.

In each of these applications, the IF amplifier processes the incoming signal, thus, the IF bandwidth of the amplifier determines the requirements of the VCO's frequency accuracy. Since the IF bandwidth of modern microwave equipment can be made fairly narrow (approximately 2 MHz,) the accuracy of the VCO is restricted to less than 2 MHz.

In modern ECM systems the VCO is often required to respond to submicrosecond commands in order to set-on a specified frequency. However, computer-controlled signal processing does not usually begin until 100 microseconds to 50 milliseconds after a tuning command. Thus, this frequency accuracy (1-10 MHz) must be achieved in the same kind of time frame (100 microseconds to 50 milliseconds) and held for periods of time anywhere from a few hundred milliseconds (in

the case of the receiver) to several minutes (in the case of the jammer).

#### Overall Modulation Sensitivity Variation

The shape of the tuning curve of a varactor-tuned oscillator is determined by the varactor capacitance-voltage characteristic and its relationship to the active impedance of the transistor or bulk-effect diode. Theoretically, the frequency response of any VCO should be a smooth function of applied voltage, with the frequency of oscillation increasing monotonically with voltage, that is, only one value of frequency exists for each value of tuning voltage across the entire frequency range.

Characteristic tuning curves for transistor doubling and bulk-effect diode oscillators over the 8 to 12 GHz range are shown in Figure 4. While the volt-

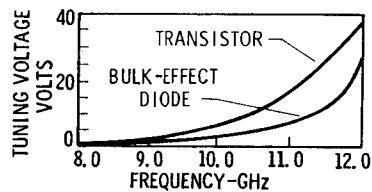

Fig. 4. Tuning characteristics of a transistor and bulk-effect diode oscillator.

age range required to tune the transistor oscillator is wider, the change in slope of the tuning curve (overall modulation sensitivity variation) of the bulk-effect oscillator is much larger.

The input capacitance of an X-band transistor is typically 1pF, while that of a bulk-effect diode is only 0.3pF when operated in the same region. Therefore, in the oscillator's series-tuned circuit the varactor used with the bulk-effect diode must have less capacitance to tune the same bandwidth as a comparable transistor oscillator. In practice, the transistor oscillator uses a varactor with 2 to 4 times greater capacitance at zero volts than the bulk-effect diode unit; at the high end of the band, the capacitance

of a varactor in a bulk-effect diode oscillator is only about 0.1pF. The increased slope ratio of the bulk-effect diode oscillator is primarily due to parasitic capacitance in parallel with the varactor. (In the example here the varactor is unpackaged). The transistor oscillator is not affected as much by the parasitics since significantly larger capacitance varactors are used.

#### Fine Grain Modulation Sensitivity Variation

In addition to the overall change in modulation sensitivity, the tuning curve exhibits fine grain variations due to the effect of the load impedance on the oscillator's resonant circuit and the presence of small parasitic resonances in the RF section. Deviations from the theoretically smooth tuning curve are most prominent in the low voltage portion of the tuning curve, therefore at the low frequency end of the VCO operating range. The oscillator is more sensitive to loading and parasitic effects in this region, since the loaded Q of the circuit is lower due to the decrease in varactor Q at these lower voltages.

The magnitude of these variations is dependent upon a number of factors, such as the required power output, amount of load isolation, the load VSWR, and the percentage tuning bandwidth. Variations as great as 2:1 or 3:1 in the slope of the tuning curve are found over a 200-300 MHz segment of the band in oscillators operating above S-Band. These variations are independent of the overall slope varia-

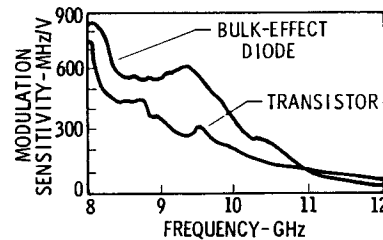

Fig. 5. Modulation Sensitivity of a transistor and bulk-effect diode oscillator.

tion of the tuning curve, which would be expected to be approximately 5:1 to 7:1 for a wideband transistor oscillator and as high as 20:1 in broadband but sub-octave bulk-effect oscillators.

Modulation sensitivity plots for the tuning curves shown in Figure 4 are illustrated in Figure 5. The bulk-effect diode oscillator overall modulation sensitivity variation is twice that for the transistor oscillator, but both types exhibit fine grain variations. Wideband performance is achieved at the expense of an increase in fine grain as well as overall modulation sensitivity variations, but narrowband units can be optimized so they exhibit little, if any, fine grain variation as shown in Figure 6.

The curves in Figures 5 and 6 were obtained using special test equipment which performs a BCD subtraction of successive digital outputs of a microwave frequency counter.

#### Post Tuning Drift

In order to describe those factors which affect PTD, it is necessary to divide the time after a step change in tuning voltage into two intervals: short term and long term. Thermal affects, such as, changes in junction temperature of the active elements and the stability of bias sources, are the primary factors contributing to short term PTD. On the other hand, varactor "charging" which is an impurity ion build-up around the junction over a period of time is the predominant cause of long term PTD.

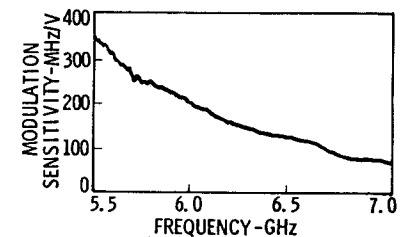

Fig. 6. Modulation Sensitivity of a transistor VCO.

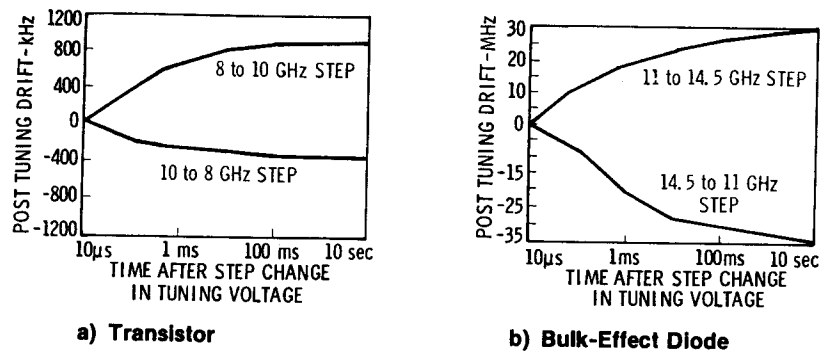

Fig. 7. Short term Post Tuning Drift of a) a transistor VCO (WJ-2835) over the 8-10 GHz range and, b) a bulk-effect diode VCO (WJ-2863) over 11-14.5 GHz range.

### Short Term Post Tuning Drift

The VCO's very wide input bandwidth allows it the capability of slewing at nanosecond rates. For a VCO with 50 pF input capacitance driven by a 50 ohm source, 20 ns would be required to slew to an accuracy of 0.05%. The time constant of the input circuit is only 2.5 ns. However, during operation, the junction temperatures of the active elements (varactor, bulk-effect diode or transistor) change due to changes in loading and RF circuit efficiency. This results in changes in the impedance of each device, and therefore will cause a shift in frequency. The duration of short term PTD depends upon the thermal impedance associated with each device. Bias circuits must also be stable on a short term basis since VCOs are sensitive to bias voltage changes.

### • Varactor Thermal Time Constant

The transient behavior of the junction temperature depends on thermal impedances of the varactor and associated packaging and circuit configuration. While the varactor junction alone could change temperature in less than 100  $\mu$ s, the varactor package, when mounted in the RF circuit, may require 10-100 ms to stabilize. When the varactor is mounted on the base of the transistor, heat generated at the varactor junction must flow through

the varactor die, varactor package, and the transistor package before reaching the oscillator housing which serves as a heat sink.

Varactors operating below 12 GHz are normally made from silicon, but in Ku-Band, GaAs varactors are used to achieve the required output power because of their higher Q. The varactor in a bulk-effect diode oscillator is normally heat sunk directly to the oscillator housing, and drift caused by the package thermal impedances is much lower. However, GaAs has a higher thermal resistance than silicon and the GaAs varactors are physically smaller in order to achieve the required capacitance. The result is, even with improved heat sinking and high Q factor varactors, PTD in bulk-effect diode oscillators is a factor of two to four times higher than in similar transistor oscillators.

An example of the short term PTD characteristic of an 8.0-10.0 GHz transistor oscillator is shown in Figure 7a. The total drift for this oscillator is less than 1 MHz for the time period from 10  $\mu$ seconds to 10 seconds after a step change in tuning voltage. The dramatic increase in short term PTD of a GaAs varactor oscillator over the 11 to 14.5 GHz frequency range is shown in Figure 7b.

• **Transistor And Bulk-Effect Diode Thermal Time Constant** The transistor or bulk-effect diode exhibits transient junction temperature changes similar to that of the varactor, therefore, producing additional PTD. In general, short term drift in transistor oscillators is significantly reduced by decreasing the input bias power. A 40 percent reduction in the input bias can result in a reduction of PTD by a factor of from 5-10. The oscillator of Figure 8a is a high power (20-50 mW) 4-8 GHz unit exhibiting 12 MHz PTD from 10  $\mu$ s to 10 seconds. By reducing input bias power and therefore power output, the same oscillator exhibited a maximum of 4 MHz PTD as shown in Figure 8b.

Figures 8a and 8b also show that the full band step is not always the worst case PTD condition. For octave bandwidth transistor oscillators, stepping from the high end to the point of highest output power generally creates the greatest PTD, even worse than stepping to the low end of the band.

Short term PTD can be reduced in bulk effect diode VCOs by using diodes with lower operating current levels but the same physical size and mounting configuration. The 11-14.5 GHz oscillator of Figure 7b exhibited a maximum of 35 MHz PTD and had an operating current of 600 mA. Using a 300 mA diode, this was reduced to a maximum of 19 MHz as shown in Figure 8c.

• **Bias Circuits And Regulators** For a VCO, the change in output frequency resulting from a change in bias is approximately 0.5% per volt. Therefore, a significant change in PTD will occur due to changes in the transistor or bulk-effect diode load presented to the bias supply, unless the bias supply is stable. Since the load of the transistor or bulk-effect diode oscillator varies with frequency because of changing RF levels and device efficiency, the bias circuitry design becomes critical. In some cases the bias circuit may also be used to compensate for the PTD of the RF circuit, but this is a very special case and does not always yield reduced PTD.

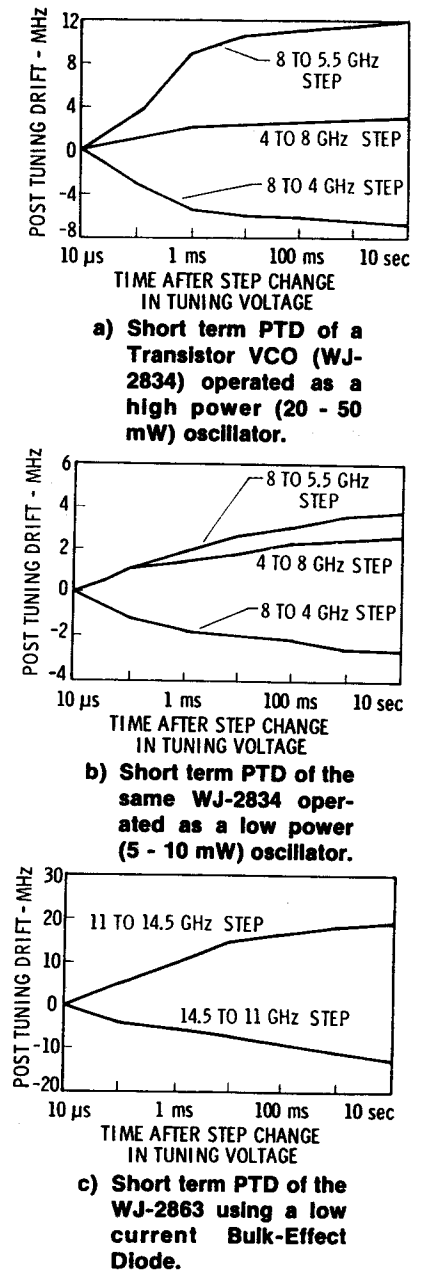

Fig. 8. Reduced short term PTD produced by decreasing the input bias, and by using a lower operating current bulk-effect diode.

### Long Term Post Tuning Drift

The above factors are all related to short term drift effects. VCOs also exhibit a long term PTD caused by the varactor "charging" effect. The "charging" effect is the term given to a reversible impurity ion build-up around the varactor junction over a long period of time under reverse bias voltages. As shown in Figure 9a, impurity ions will build up around the junction in the presence of an electric field. This causes a change in the capacitance of the varactor and therefore in the operating frequency of the oscillator. Impurity ions remain after etching and other processes even though the varactor chip is cleaned and the case hermetically sealed. Long term PTD of silicon varactors is significantly reduced by applying a heavy passivation layer around the junction to reduce the build-up, Fig. 9b.

Recent advances in varactor technology have now reduced long term PTD to less than 1 MHz drift over a one-hour period. Long term PTD is illustrated in Figure 10a for a transistor oscillator using specially passivated silicon varactors.

GaAs varactors are not yet developed which reduce the "charging" effect as has been done for silicon devices. Long term PTD of a bulk-effect diode oscillator using an unpassivated GaAs varactor, therefore, is significantly poorer as shown in Figure 10b.

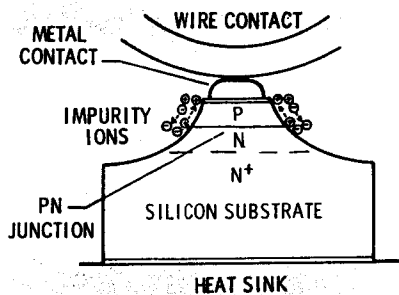

a) Formation of ion build-up around the PN junction of the varactor.

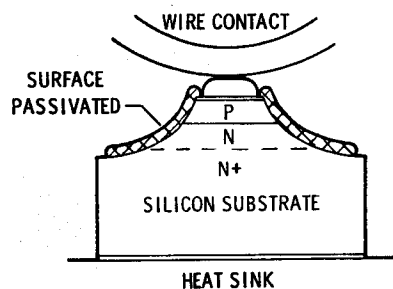

b) Passivation layer across the PN junction reduces ion build-up.

Fig. 9. Long term post tuning drift resulting from varactor "charging".

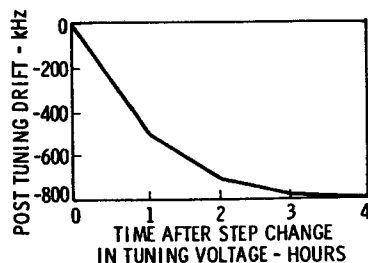

a) Transistor

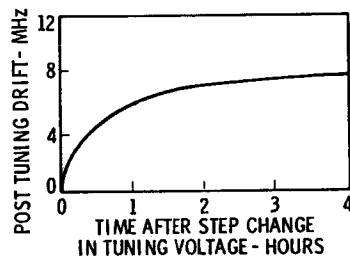

b) Bulk-Effect Diode

Fig. 10. Long term PTD of a) a transistor VCO (WJ-2835) over the 8-10 GHz frequency range and, b) a bulk-effect diode VCO (WJ-2863) over the 11-14.5 GHz frequency range.

### Summary

Improvement in design of oscillator components and the oscillator itself are directly responsible for the reduced post tuning drift and fine grain modulation sensitivity variation of today's varactor-tuned sources. Significant improvements in short term PTD have resulted from reduction in the junction temperatures of all active devices. Also, lower long term PTD has been achieved by advances in varactor manufacturing techniques. Reduction in fine grain modulation sensitivity is the result of developing equipment to readily measure it, recognizing its causes and establishing alignment techniques to achieve consistent results.

Further improvement in short term PTD depends upon improving the thermal characteristics of the oscillator components. Development of each of the following will provide lower, more stable junction temperatures and therefore lower PTD.

- Plated heat sink passivated flip-chip varactor.
- Larger area or multiple junction microwave transistors having a gain-bandwidth product as high as the presently available smaller area devices.
- Lower thermal impedance packages for microwave components.
- Lower operating current bulk-effect diodes.

Long term drift in GaAs varactor oscillators can be reduced if the varactor can be passivated as has been done with silicon. This will be a key factor in the development of new or improved ECM systems utilizing frequencies above 12 GHz.

The increased emphasis being placed upon VCO device and circuitry development will provide a means to achieve many of these improvements.



Author: Ronald N. Buswell  
Ronald N. Buswell received his B.S.E. at the Michigan Technological University and M.S.E. at the University

of Michigan. He became a member of the technical staff at W-J's Stewart Division in 1971, and is currently Head, Design Engineering Section, Solid State Department. Mr. Buswell is responsible for the development of new VCO products such as militarized and bulk-effect diode oscillators, design of new and improved linearizer circuitry and surveillance of microwave transistors and varactors to maintain acceptable performance. Ron received honorable mention in Eta Kappa Nu's "Outstanding Electrical Engineering Student" awards for 1970, and is a member of the IEEE, GMITT, Eta Kappa Nu, Tau Beta Pi and Phi Eta Sigma.

## TECHNICAL DEFINITIONS

- Frequency Pulling:** The total frequency excursion observed as a load of the specified VSWR varies over 360 electrical degrees.
- Residual F.M. (peak):** The peak-to-peak deviation of the output signal as observed on a spectrum analyzer with a 1KHz IFBW at -10 dBc. See Figure 11.

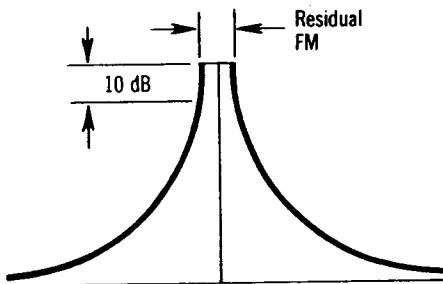

Note: Bias and tuning voltages are to be filtered to eliminate ripple.

Figure 11

- Harmonic Rejection:** The level of harmonically related signals relative to the desired output signal level, measured in dB.
- Non-Harmonic Spurious Rejection:** The level of signals not harmonically related to the output signal, relative to the desired output, measured in dB. Usually, only in-band spurious signals are measured.
- Frequency Pushing:** The change in operating frequency produced by a change in bias voltage (within the specified limits of bias voltage for the unit).
- Frequency Drift with Temperature:** The change in operating frequency produced by a change in operating temperature. The operating temperature is measured on the baseplate.
- Non-linearity:** The maximum deviation from a straight line drawn between two pre-determined points on a tuning voltage vs. frequency graph, expressed as a percentage of the absolute frequency.

- Frequency Accuracy:** The maximum deviation from a straight line drawn between two pre-determined points on a tuning voltage vs. frequency graph, produced by the combined effects of tuning non-linearity and frequency drift with temperature.

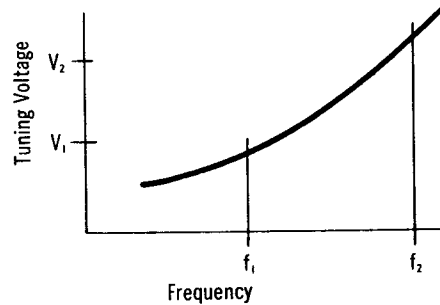

Figure 12

- Monotonicity:** A unit is monotonic if  $V_2(f_2) > V_1(f_1)$  for  $f_2 > f_1$  where  $f$  is frequency and  $V$  is voltage. See Figure 12.
- Power Output Variation:** The extremes of output power (min. to max.) measured over the entire frequency range as measured into a specified VSWR (all phases). Temperature effects are not included.
- Post Tuning Drift:** The shift in oscillator frequency output as a function of time after a step change in tuning voltage. The time interval of importance must be specified.
- Modulation Sensitivity:** The reciprocal of the slope of the tuning voltage vs. frequency graph, as measured in MHz/V.
- Threshold Current:** The current at the point that the slope ( $dl/dV$ ) of the current vs. voltage graph of a bulk effect diode is zero. This is the maximum current that occurs before the diode goes into its negative resistance region.
- Operating Current:** The current required by the oscillator during steady state operation.
- Full Band Tuning Response Time:** The time after a full band step in frequency required for the output to slew to within 63% of final frequency.

### References:

- Bushnell, T. R., R. N. Buswell, "Microwave Varactor Tuned Oscillators," presented by Watkins-Johnson Co. at the Western Electronic Show and Convention, 1974.
- Hoglund, B., A. Isaacs, "Varactor-Tuned Oscillators," Application Note (DCN100465A) originated at the Watkins-Johnson Co.
- Johnson, K. M., "Microwave Varactor Tuned Transistor Oscillator Design," IEEE Trans on MTT, MTT-14, November 1966, pp 564-572.
- Watson, H. A., "Microwave Semiconductor Devices and Their Applications," McGraw-Hill Book Company, New York, 1969.